

# IMPLANT TRIBUNE

— The World's Dental Implant Newspaper • U.S. Edition —

NOVEMBER 2012 — VOL. 7, No. 11

www.dental-tribune.com

## Periodontists meet in L.A.

### *AAP hosts its 98th annual meeting*

By Sierra Rendon, Managing Editor

**T**he American Academy of Periodontology, in collaboration with the Japanese Society of Periodontology, hosted its 98th annual meeting from Sept. 29–Oct. 2 in Los Angeles.

Courses and topics ranged greatly from implants and regenerative therapy to growing your practice to a retrospective look at periodontal plastic surgery.

Speakers included Drs. Sonia Leziy, Christopher Church, Stephen S. Wallace, Kenneth S. Kornman, David W. Paquette, Yuichi Izumi, George E. Romanos, Richard Goren, Morton C. Rennert, Linda Vidone, Paul A. Levi Jr. and Eduardo Marcuschamer, among many others.

The AAP also hosted a post-annual meeting C.E. symposium. Immediately following the annual meeting, taking place Oct. 4–5 at the Resort at Pelican Hill in Newport Beach, this year's program featured two half-day sessions, allowing attendees to learn in a more focused and intimate environment.

To see photos from the AAP annual meeting, see Pages B4 and B6.



Dr. Stephen Wallace speaks on 'Innovative Sinus and Nasal Elevation Techniques' at the AAP Annual Meeting in Los Angeles.

## Group aims to get word out on connection between periodontal disease and diabetes

**N**ovember is American Diabetes Month, and the New Jersey Society of Periodontists (NJSP) is reaching out to patients and caregivers alike to be aware of the link between periodontal disease and diabetes.

"If you have diabetes, you are at higher risk for developing infections, including periodontal disease," explains Dr. Scott Zirkin, president of the NJSP.

"These infections can impair the ability to process and/or utilize insulin, which may cause your diabetes to be more difficult to control and your infection to be more severe than a person with the disease," Zirkin said.

People with diabetes are more likely to have periodontal disease than people without diabetes, most likely because they are more susceptible to contracting

infections. In fact, periodontal disease is often considered the sixth complication of diabetes, and those people who don't have their diabetes under control are especially at risk.

A recent study in the Journal of Periodontology found that poorly controlled Type 2 diabetes patients are more likely to develop periodontal disease than well-controlled diabetes patients are. Moreover, research has emerged that suggests that the relationship between periodontal disease and diabetes goes both ways — periodontal disease may make it more difficult for people who have diabetes to control their blood sugar.

"We are very much aware of the link between periodontal disease and diabetes and understand the importance of the collaborative care of a periodontist and a

physician," said Gina Murdoch, executive director of the American Diabetes Association, New Jersey Area.

A study was published a few years back in the Journal of Periodontology that involved patients with both diabetes and periodontal disease. The study found that when their periodontal infections were treated, the management of their diabetes markedly improved.

"The mouth/body connection is very strong and should not be underestimated by those living with diabetes or their caregivers," Zirkin said.

According to Zirkin, severe periodontal disease can increase blood sugar, contributing to increased periods of time when the body functions with high blood sugar levels. This puts diabetics at a higher risk for diabetic complications. Thus, diabet-

ics who have periodontal disease should be treated by a specialist to control and/or eliminate the periodontal infection.

### **About NJSP**

The New Jersey Society of Periodontists (NJSP) is an organization of New Jersey dentists who specialize in the art, science and practice of periodontics, including implants. The group is dedicated to advancing the knowledge base and understanding of periodontal diseases, as well as advancing ideas in treatment techniques in implantology. The NJSP seeks to explore and discuss problems of mutual interest with those in the practice of periodontics and implant dentistry.

(Source: New Jersey Society of Periodontists)

# A perfect body or a perfect smile?

Consumers say they would pay to fix their teeth before they would pay for weight loss help, according to new research from the American Academy of Cosmetic Dentistry (AACD).

The findings are good news for cosmetic dentists — they suggest that the demand for cosmetic dentistry is stronger than ever.

Of the 80 percent of American adults who in a recent poll admitted they would spend money to hide or correct aging flaws, 62 percent said they would pay to fix the quality of their teeth, compared with 48 percent who said they would invest in weight loss help.

Women are more likely than men to invest in such improvements (84 percent

versus 75 percent).

Nearly half (45 percent) of Americans think a person's smile can defy aging's effects while eyes come in a distant second (34 percent). In comparison, very few adults find the following features less likely to age well:

- Body shape (10 percent)
- Hair (6 percent)
- Legs (5 percent)

Perhaps speaking from experience, 54 percent of Americans older than 50 attest that a smile can overcome decades of birthdays in contrast to only 38 percent of 18- to 29-year olds.

"A great smile is always in style, and these results prove it," said AACD Presi-

dent Dr. Ron Goodlin. "Cosmetic dental professionals can rest assured that their services will always be needed."

The AACD's research was completed through a survey with Kelton Global in recognition of Healthy Aging Month, which takes place in September. Kelton Global polled 1,018 American adults ages 18 and older questioning them about their attitudes related to aging and beauty.

The AACD Smile Survey was conducted between Aug. 17 and Aug. 23 among 1,018 nationally representative Americans ages 18 and older, using an email invitation and an online survey. Margin of error is plus/minus 3.1 percent.

(Source: AACD)

## IMPLANT TRIBUNE

### PUBLISHER & CHAIRMAN

Torsten Oemus [t.oemus@dental-tribune.com](mailto:t.oemus@dental-tribune.com)

### CHIEF OPERATING OFFICER

Eric Seid [e.seid@dental-tribune.com](mailto:e.seid@dental-tribune.com)

### GROUP EDITOR

Robin Goodman [r.goodman@dental-tribune.com](mailto:r.goodman@dental-tribune.com)

### MANAGING EDITOR IMPLANT TRIBUNE

Sierra Rendon [s.rendon@dental-tribune.com](mailto:s.rendon@dental-tribune.com)

### MANAGING EDITOR SHOW DAILIES

Kristine Colker [k.colker@dental-tribune.com](mailto:k.colker@dental-tribune.com)

### MANAGING EDITOR

Fred Michmershuizen  
[fmichmershuizen@dental-tribune.com](mailto:fmichmershuizen@dental-tribune.com)

### MANAGING EDITOR

Robert Selleck [r.selleck@dental-tribune.com](mailto:r.selleck@dental-tribune.com)

### ACCOUNT MANAGER

Humberto Estrada [h.estrada@dental-tribune.com](mailto:h.estrada@dental-tribune.com)

### ACCOUNT MANAGER

Charles Serra [c.serra@dental-tribune.com](mailto:c.serra@dental-tribune.com)

### MARKETING DIRECTOR

Anna Wlodarczyk-Kataoka  
[a.wlodarczyk@dental-tribune.com](mailto:a.wlodarczyk@dental-tribune.com)

### C.E. DIRECTOR

Christiane Ferret [c.ferret@dtstudyclub.com](mailto:c.ferret@dtstudyclub.com)

Dental Tribune America, LLC  
116 West 23rd Street, Suite 500  
New York, NY 10011  
Phone (212) 244-7181  
Fax (212) 244-7185

Published by Tribune America  
© 2012 Tribune America, LLC  
All rights reserved.

Tribune America strives to maintain the utmost accuracy in its news and clinical reports. If you find a factual error or content that requires clarification, please contact Managing Editor Sierra Rendon at [s.rendon@dental-tribune.com](mailto:s.rendon@dental-tribune.com).

Tribune America cannot assume responsibility for the validity of product claims or for typographical errors. The publisher also does not assume responsibility for product names or statements made by advertisers. Opinions expressed by authors are their own and may not reflect those of Tribune America.

### EDITORIAL BOARD

Dr. Pankaj Singh  
Dr. Bernard Touati  
Dr. Jack T. Krauser  
Dr. Andre Saadoun  
Dr. Gary Henkel  
Dr. Doug Deporter  
Dr. Michael Norton  
Dr. Ken Serota  
Dr. Axel Zoellner  
Dr. Glen Liddelow  
Dr. Marius Steigmann

AD

**Academy of Osseointegration**  
**28th Annual Meeting**  
**March 7-9, 2013**  
**Tampa Convention Center • Tampa, Florida**

**Moving Forward: Evidence, Experience, Excellence**

- Opening Symposium: *Quality Evidence – Quality Treatment – Quality Outcomes*  
Featuring: Edward Alan; Daniel Buser; Lyndon Cooper; Richard Roblee; Clark Stanford & Robert Winter
- 36 Corporate Forum Presentations
- Commercial Exhibits
- Emerging Treatment Option Sessions (New)
- Limited Attendance Lectures
- Lunch and Learn Presentations
- Poster Presentations
- Round Table Clinics
- Restorative & Surgical Tracks
- Social Events
- Treatment Approaches
- Closing Symposium: *Where Are We Today and What Does the Future Hold?*  
Featuring: Urs Belsler; David Garber; Joseph Kan; Henry Salama; Maurice Salama; & William Scarfe

 [osseointegration.org](http://osseointegration.org)

 ADA CERP® Continuing Education Recognition Program

## Corrections

Implant Tribune strives to maintain the utmost accuracy in its news and clinical reports. If you find a factual error or content that requires clarification, please report the details to Managing Editor Sierra Rendon at [s.rendon@dental-tribune.com](mailto:s.rendon@dental-tribune.com).

## Tell us what you think!

Do you have general comments or criticism you would like to share? Is there a particular topic you would like to see articles about in Implant Tribune? Let us know by e-mailing [feedback@dentaltribune.com](mailto:feedback@dentaltribune.com). We look forward to hearing from you! If you would like to make any change to your subscription (name, address or to opt out) please send us an e-mail at [database@dental-tribune.com](mailto:database@dental-tribune.com) and be sure to include which publication you are referring to. Also, please note that subscription changes can take up to six weeks to process.

# SOME IMPLANTS ARE OKAY WITH "ALMOST" COMPATIBLE.



## REALLY?



### Compatibility.

Uses the same drills, drivers, and prosthetics.

### Confidence.

Knowing your referrals already have the right components.

### Cost.

Only \$145.99 per implant, why pay more?



ACE Surgical Supply Co., Inc.  
1034 Pearl Street, Brockton, MA

1.800.441.3100 • [acesurgical.com](http://acesurgical.com)



## THE SYNTHETIC SOLUTION TO BONE REGENERATION

### NOVABONE<sup>®</sup> DENTAL PUTTY

**NovaBone<sup>®</sup>** is the only dental bone graft putty that is completely synthetic with excellent and reliable bone formation characteristics. It is indicated primarily for implant related surgeries including but not limited to sinus elevation surgeries, extraction sockets, ridge augmentations, etc. Putty does not require mixing as it is dispensed in a pre-mixed state ready for implantation!

**NovaBone Dental Putty** is available in multiple delivery mechanisms including syringes, shells & cartridges. The consistency and formulation of the putty is identical in the various delivery systems.

#### NOVABONE DENTAL PUTTY CARTRIDGE SYSTEM

<b>A</b> NA3620	0.5cc Cartridges	2/pkg	\$225.00
<b>A</b> NA3640	0.5cc Cartridges	4/pkg	430.00
<b>B</b> NA3621	1.0cc Cartridges	2/pkg	410.00
<b>C</b> NA3600	Cartridge Dispenser	each	99.99

#### NOVABONE DENTAL PUTTY SYRINGE

<b>D</b> NA1610	0.5cc Syringe	1/pkg	\$105.00
<b>D</b> NA1611	1.0cc Syringe	1/pkg	190.00
<b>D</b> NA1612	2.0cc Syringe	1/pkg	335.00

#### NOVABONE DENTAL PUTTY CLAM SHELL

<b>E</b> NA0610	0.5cc Clam Shell	1/pkg	\$90.00
<b>E</b> NA0660	0.5cc Clam Shell	6/pkg	439.49
<b>E</b> NA0611	1.0cc Clam Shell	1/pkg	170.00
<b>E</b> NA0622	1.5cc Clam Shell	2/pkg	391.99

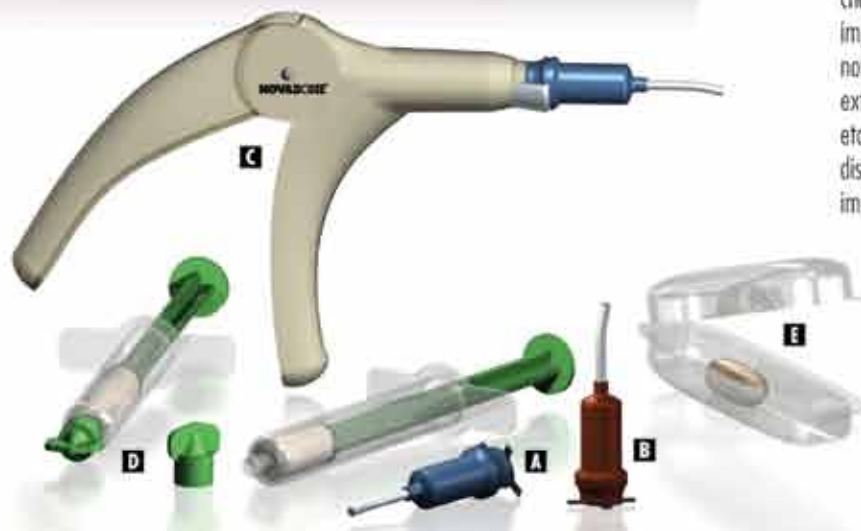

ACE Surgical Supply Co., Inc.  
1034 Pearl Street, Brockton, MA

1.800.441.3100 • [acesurgical.com](http://acesurgical.com)





An AAP attendee stops by the Anatomage booth to learn more about the company's products.



Impladent President Maurice Valen shows off the company's prefabricated immediate implant splinting system.



Attendees visit the Implant Direct booth to learn more about the company's vast implant options.

AD

# C1

## A Conical Connection Implant

All C1 implants, superstructures and tools are color coded to simplify platform identification.





**Platform Switching**  
Promotes vital soft tissue growth and reduces bone resorption



**Micro Rings**  
Improve the bone to implant contact at the crestal zone by increasing surface area



**Dual Thread Design**  
Increases bone to implant contact, reinforces osseointegration and enhances primary stability

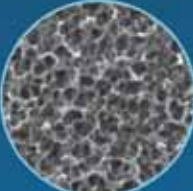

**Surface Treatment**  
Creates an osseoconductive morphology and achieves superb osseointegration results

Visit Booth #1623 at the Greater NY Dental Meeting  
 Priced at \$249.00, each C1 implant is packaged with a single use final drill, cover screw, and PEEK abutment. To learn more about MIS, visit our website: [www.misimplants.com](http://www.misimplants.com) or call: **866-797-1333 (toll-free)**





The folks from Dentatus show attendees how its Anew Implant can fit where no others can.



DoWell offers innovative products such as the PiezoART, an ultrasonic bone-cutting system, driven with piezoelectric technology.



AAP attendees stop by the ACE Surgical Supply booth. The company says it continues to develop and manufacture the highest quality, state-of-the-art products.

*Photos/Sierra Rendon,  
Managing Editor*

OSTEOGENICS

BIOMEDICAL

“**OUTSTANDING.**  
A GAME CHANGER. RELEVANT. GREAT. USER-FRIENDLY.  
**EXCELLENT. REMARKABLE. TESTED.**  
TIME-**DEPENDABLE. RELIABLE.**  
SAVING. **STABLE. PROVEN IDEAL.**  
**POSITIVE. PROVEN** COST-EFFECTIVE.  
GUARANTEED. **CERTAIN. EFFECTIVE.**  
**SUCCESSFUL. CONSISTENT.**  
**PREDICTABLE. PREFERRED. SURE.”**  
**TRUSTWORTHY**”



**Big words for such a small membrane**, but Cytoplast™ TXT-200 Singles have lived up to those words from your colleagues for more than 15 years.

osteogenics.com | 888.796.1923



Dr. Nicholas Caplanis moderates a session at the AAP annual meeting.



Glidewell Laboratories shows off its products, such as the Inclusive Implant System.



AAP attendees head to the Hiossen booth to hear a speaker on the exhibit hall floor.

AD

# PhotoMed gives you options

Configure your Canon camera with the flash that is right for you



The macro flash that you use for dental photography has a huge impact on the quality of your images. Not all macro flashes are up to the task and many that are being offered are not compatible with the cameras they are being sold with.

When it comes to outfitting a Canon digital camera with a macro flash, the best choices come from Canon, Metz and Sigma. Real flashes from real flash manufacturers - not "frankenflashes" that look like they were assembled in someone's garage.

When you call the experts at PhotoMed, they can help guide you to the right flash for your system. Need a complete camera that includes unlimited support? We can help with that too.

Call us and find out why we're known for the best camera equipment and the best support available.

## PhotoMed [www.photomed.net](http://www.photomed.net) • 800.998.7765

Come see us at a dental meeting near you. Complete list of upcoming meetings at: [www.photomed.net](http://www.photomed.net)  
Take photos, pick our brains and get the best dental camera advice available.



The Los Angeles Convention Center was the site of the AAP's annual meeting.



Attendees flock to the Materialise booth to hear more about its products.



Piezosurgery empowers surgeons to perform procedures that simply aren't possible using more traditional instruments, the company says.



PhotoMed can meet all your dental photography needs.



## 1-Year Master Clinician Program in Implant Dentistry | 7 Worldwide Locations



### CURRICULUM

#### Session I - 4 Days



**Optimal Implant Placement, Bone Regeneration & Implant Prosthodontics**

#### Session II - 4 Days



**Soft Tissue Management/Esthetics Around Implants & Advanced Implant Prosthodontics**

#### Session III - 4 Days



**Advanced Implant Surgery & Esthetic Implant Prosthodontics**

#### Session IV - 5 Days at UCLA School of Dentistry



**Live Surgery Patient Demonstrations & Implant Research Update at UCLA School of Dentistry**

### EXPERT FACULTY

Dr. Sascha A. Jovanovic, Periodontist, Program Chair  
 Dr. Egon Euwe, General Dentist  
 Dr. Istvan Urban, Periodontist  
 Dr. Ed McLaren, Prosthodontist  
 Dr. Joseph Kan, Prosthodontist  
 Dr. Henry Takei, Periodontist  
 Dr. Bernard Touati, Prosthodontist  
 Prof. Massimo Simion, Oral Surgeon  
 and others....

### PROGRAM FEATURES

- Complete Implant Curriculum
- Full gIDE 1 Year Membership
- Live Surgery Demonstrations
- Hands-On Workshops
- Case Reviews & Exams
- iPad Self-Study Lectures & Videos
- Online Forum
- Literature Review
- 260 Implant CE Hours
- Patient Education Software
- Certifications from gIDE & UCLA CE



*"The Master Clinician Program is everything I expected. It has allowed me to implement many implant procedures, both basic and advanced, immediately into my practice."*

- Dr. David Azar, New York, New York - America Master Clinician Program 2009-2010

*"The Master Clinician Program is an excellent training course to gain confidence in approaching advanced and complex implant patients. It helped me to achieve a scientific and evidence-based approach to my patient concerns. I would highly recommend this course to anyone interested in providing the best and informed treatment for their patients."*

- Dr. Gordon Wong, Toronto, Canada - America Master Clinician Program 2011



# Tired of Price Increases on Over-Priced Implants?

It's Time for a Reality Check. Choose Implant Direct for...  
Innovative Products. Great Value. Highest Customer Satisfaction<sup>1</sup>

## Legacy™3 Implant

All-in-1 Packaging includes Implant, abutment, transfer, cover screw & healing collar  
\$175 vs \$621<sup>2</sup> from Zimmer Dental

✓ **Reality Check**  
Zimmer Customers  
Save \$446 with Legacy<sup>3</sup>



## SwishPlant™ Implant

All-in-1 Packaging includes implant, straight abutment/transfer, cover screw & healing collar  
\$200 vs \$705<sup>2</sup> from Straumann®

✓ **Reality Check**  
Straumann Customers  
Save \$505 with SwishPlant



## ReActive™ Implant

All-in-1 Packaging includes implant, abutment, transfer & cover screw  
\$200 vs \$694<sup>2</sup> from Nobel Biocare™

✓ **Reality Check**  
Nobel Customers  
Save \$494 with ReActive



## Implant Direct's New Las Vegas Training Center

Implant Direct offers an extensive list of educational opportunities at its Las Vegas Training Center with computers at each desk for image Guided Surgical Training, models/mannequins for hands-on training and a four chair dental office for live surgical demonstrations.

For information on courses and dates, both in Las Vegas and throughout the US, visit Implant Direct's website or use your smart phone to link directly to our Educational Section.



**EARN 2 CE CREDITS FREE: View Online Lecture with 3D Graphic Videos & Answer 13 Test Questions**



## The Changing Reality of Implant Dentistry

Presented by Dr. Gerald Niznick

Technological advances and economic factors have shifted the implant industry toward affordable care.

**Intro Offer: Make the switch & receive three FREE implants<sup>3</sup>**

**Buy 1 Zirconia \$120 abutment and receive 1 Free Titanium \$85 abutment<sup>4</sup>**  
(or \$85 credit for any 2nd abutment). For online orders enter ZR85 in coupon code box

<sup>1</sup> Live Surgical Demonstrations not available at all locations.  
<sup>2</sup> All trademarks are property of their respective companies.  
<sup>3</sup> Transfered among Current and Former Users by Company US Q211 Millennium Research Group A Decision Research, Inc. Company.  
<sup>4</sup> Price comparison based upon US list prices of comparable items as of February 2012.  
<sup>5</sup> Terms and conditions apply. List price offer per practice. Free abutment not to exceed \$85 value. No cash value.  
<sup>6</sup> Comparison based upon Straumann's CARES Custom Zirconia Abutment. Price varies depending upon the laboratory.  
LOCATOR® is a registered trademark of Zett Anchors Company. The GoGuide™ and GPS™ Systems are neither authorized, endorsed nor sponsored by Zett Anchors Company.



Approved PACE Program Provider FAGD/MAGD Credit  
Approval does not imply acceptance by a state or provincial board of dentistry or AGD endorsement  
8/01/2012 to 7/31/2015  
Provider ID# 116714



# Simply Smarter Prosthetic Solutions

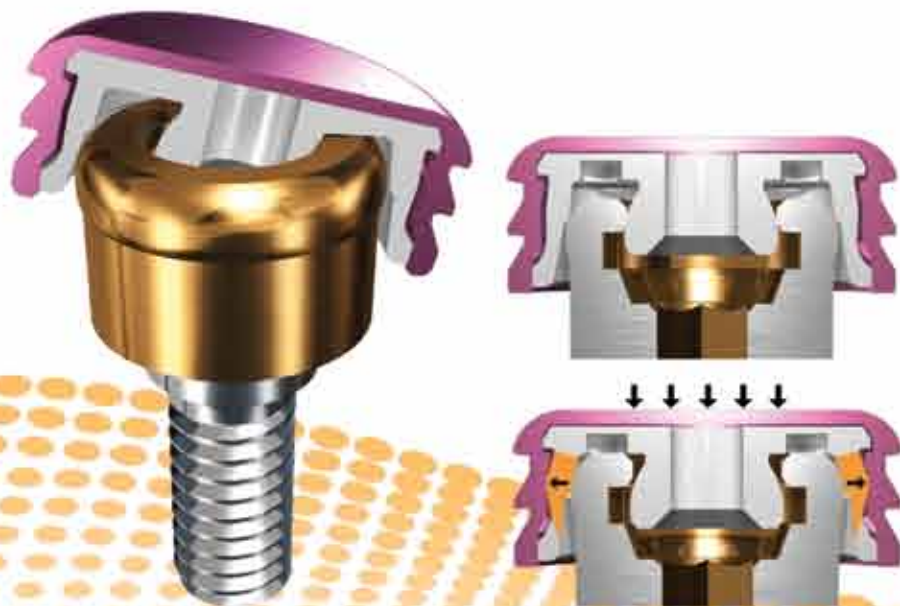

GPS® Abutment in 5 Collar Heights - \$100  
NEW GPS™ Internal Attachment provides vertical and rotational stress-breaking



Zirconia Abutment on Anodized Titanium Bases - \$120

Anodized Titanium Bases for Custom Zirconia Abutments - \$60

**GPS™ Overdenture Attachment System** features Straight & Angled Abutments that provide a retentive platform compatible with LOCATOR® attachments. All-in-1 Packaging includes Anodized Housing with 5lbs Retentive Nylon Liner (nylon liners in 1.5, 3 & 5lbs - 4 for \$22) & Transfer. Straight Abutments accommodate up to 20° divergence while 15° & 30° Angled Abutments are suited for overdentures on angled implants.

**Zirconia Abutments on Titanium Bases** combine esthetics with strength & precision for restorations in the esthetic zone. The titanium base is gold anodized to maintain the natural tooth color of the zirconia while providing structural support. These stock abutments with contoured margins are provided in 0°, 8° & 15° with 1 & 2mm collar heights to minimize the need for preparation, thereby providing the benefits of custom abutments at less than half the price.

## Joining our full line of industry-compatible prosthetics



**Legacy™**  
Internal Hex  
Compatible with Zimmer, BioHorizons® MIS®



**ScrewPlant™**  
Internal Hex  
with External Bevel - ID Proprietary



**RePlant®**  
Internal Tri-Lobe  
Compatible with NobelReplace™



**Swish™**  
Internal Octagon  
Compatible with Straumann Tissue Level



	Laboratory Abutment	Straight Snap-On	Straight Contoured	15° Angled Contoured	Gold/Plastic	Zirconia/Ti Abutment	Angled Zirconia/Ti Abutment	Plastic Temporary Abutment	Ball Attachment	GPS™ Attachment	Angled GPS™ Attachment	Multiple-Unit w/Cap & Transfer	Angled
<b>Our price</b>	\$75	\$85	\$85	\$85	\$100	\$120	\$120	\$35	\$107	\$100	\$120	\$85	\$100
<b>Zimmer Dental®</b>	\$160	\$215	\$170	\$180	\$210	\$239	\$254	\$67	\$178	\$166	N/A	\$202	\$294
<b>Straumann®</b>	N/A	\$190	\$195	\$195	\$255	\$339 <sup>d</sup>	\$339 <sup>d</sup>	\$65	\$275	\$195	N/A	\$180	N/A
<b>Nobel Biocare™</b>	\$145	\$186	\$170	\$225	\$216	\$285	\$285	\$72	\$217	\$149	N/A	\$229	\$274