

today ICOI



Computer-aided customization

Get a step-by-step look at one custom implant restoration case, from the intraoral scan to the finished product.

»page 4



Scenes from the ICOI

Clinicians from Costa Rica and Mexico join companies from around the world for a day full of fun.

»pages 6 & 7



Stop paying for expensive software

Want to perform CT-guided surgery but don't want to keep buying new software? Now you have another option.

»page 14

Look back, move forward



Attendees crowd the aisles during the first day of the ICOI World Congress on Thursday. (Photo/Anna Kataoka-Wlodarczyk, Dental Tribune)

ICOI celebrates 40 years with insight into implant dentistry's innovations, complications and controversies

For 40 years, the ICOI has been educating clinicians on implant dentistry, along with all the innovations, complications and controversies that go with it. During the next two days, the ICOI World Congress will honor that history and look back at where this one fledgling "study club" came from.

What once was run from the office of ICOI co-chair Dr. Kenneth Judy now occupies an entire floor of an office building in Upper Montclair, N.J. What

»see LOOK, page 2

AD

When you've considered all the options, isn't it time to consider



Expanding implantology with more treatment options

ANEW is the only narrow-body implant with a screw-retained prosthetic system and with over 10 years of clinical experience & research to support safe and reliable long-term use.

Available in 1.8, 2.2 & 2.4mm diameters and three thread lengths. With a tapered apical end, ANEW Implants can be placed in interdental spaces as narrow as 3.5mm without the need for bone augmentation or orthodontic interventions.

For more information visit www.DentatusUSA.com or call us at (800) 323-3136



Courtesy of Dr. Stuart Froum, 2001



VISIT
BOOTH
416

©2012 Dentatus USA, Ltd. Patented and Patents Pending

LOOK *from page 1*

once started as a small group of clinicians has now grown to encompass more than 13,000 dues-paying members and spans all continents except for Antarctica.

This week's World Congress XXIX was created and prepared by Dr. John Russo and includes a diversified and international faculty. Some of the topics to be covered include cone-beam CT diagnosis and treatment planning; the use of growth factors including stem cells; digital impressions from the perspectives of the clinician and the laboratory; and diagnosing, preventing and treating soft-tissue esthetic complications.

In addition, there are more than 100 implant dentistry-related exhibi-

tors just waiting for you in the exhibit hall to show off the newest and most advanced products and technology.

Here is a look at some of the highlights of the scientific program for today and Saturday.

Today

- 1:30 to 2:30 p.m. – Dr. Carl Misch: "Prosthetic-Related Complications"

- 2:30 to 3:30 p.m. – Dr. Rick Ferguson: "Bone Grafting – Misconceptions and Strategies for Predictable Success"

- 5 to 6 p.m. – Dr. John Russo: "Reduce Complications, Increase Confidence, Achieve Excellence"

- 7 to 8 p.m. – Awards ceremony

Saturday

- 8 to 9 a.m. – Dr. Bach Le: "Management of the Ailing Implant"

- 9 to 10 a.m. – Dr. Pablo Galindo Moreno: "Bone Level Stability Around Implants Placed in Pristine and Grafted Areas"

- 10:30 to 11:30 a.m. – Dr. Maurice Salama: "Contemporary Reconstructive Hard- and Soft-Tissue Surgery: Myths, Realities and Future Trend in Dentistry"

- 1:30 to 2:30 p.m. – Dr. Alan Fetter: "Subcrestal Implant Placement to Optimize Soft-Tissue Esthetics – Controversy and Practicality"

- 4 to 4:45 p.m. – Dr. Scott Ganz: "A Comparison of Interactive Software Applications in Assessing the Reality of Anatomy: Diagnostics and Implant Planning Accuracy"

- 6 to 6:30 p.m. – Dr. Konstantinos Valavanis: "Perimplant Tissue Design: Parameters and Key Factors for Optimum Esthetics"

AD

The 32nd Moscow International Dental Forum

Moscow 2012

The 32nd Moscow International Dental Forum

Dental-Expo
international dental fair

September 17-20
Crocus Expo exhibition grounds

more than **450** exhibitors

more than **25000** attendees

more than **35** countries

www.dental-expo.com

DENTALEXPO®

today About the Publisher

Dental Tribune America, LLC
116 W. 23rd St., Suite 500
New York, N.Y. 10011
Phone: (212) 244-7181
Fax: (212) 244-7185
E-mail: info@dental-tribune.com
www.dental-tribune.com

Publisher & Chairman
Torsten Oemus
t.oemus@dental-tribune.com

Chief Operating Officer
Eric Seid
e.seid@dental-tribune.com

Group Editor
Robin Goodman
r.goodman@dental-tribune.com

Managing Editor Show Dailies
Kristine Colker
k.colker@dental-tribune.com

Managing Editor
Fred Michmershuizen
f.michmershuizen@dental-tribune.com

Managing Editor
Sierra Rendon
s.rendon@dental-tribune.com

Managing Editor
Robert Selleck
r.selleck@dental-tribune.com

Account Manager
Gina Davison
g.davison@dental-tribune.com

Account Manager
Humberto Estrada
h.estrada@dental-tribune.com

Account Manager
Will Kenyon
w.kenyon@dental-tribune.com

Account Manager
Mara Zimmerman
m.zimmerman@dental-tribune.com

Marketing Director
Anna Kataoka-Wlodarczyk
a.wlodarczyk@dental-tribune.com

C.E. Director
Christiane Ferret
c.ferret@dtstudyclub.com

dti Dental Tribune International

Published by Dental Tribune America
© 2012 Dental Tribune America, LLC
All rights reserved.

today appears during the ICOI World Congress in Orlando, Florida, September 21, 2012.

Dental Tribune America makes every effort to report clinical information and manufacturers' product news accurately, but cannot assume responsibility for the validity of product claims, or for typographical errors. The publishers also do not assume responsibility for product names or claims, or statements made by advertisers. Opinions expressed by authors are their own and may not reflect those of Dental Tribune America or Dental Tribune International.

MIS Implants offers new conical connection implant

■ MIS Implants Technologies has recently launched the new C1 implant system. This new C1 system brings a combination of proven and innovative design features to market, including a conical connection and abutments that utilize a platform-switching concept.

The 6-degree conical connection ensures a secure fit between the abutment and implant. By minimizing micro-movement at that junction, bone loss at the crestal level is reduced. There is a six-position cone index within the conical connection to help orient the implant during insertion and place the abutment into the proper position.

Implants, abutments and tools are color-coded according to platform size for easy identification. The standard platform refers to the 3.75 and 4.2 mm diameter implants, while the 5 mm diameter implant is the wide platform. Lengths for all of the diameters come in 8, 10, 11.5, 13 and 16 mm.

The C1 implant (as all of the MIS implants) is made from a titanium alloy that contains titanium, aluminum and vanadium known as Ti-6Al-4V-ELI (Grade 23). This alloy has high fatigue strength and is highly biocompatible. Similar to commercially pure titanium implants (Grades 1-4), the outer surface of these implants consists of a thin layer of pure titanium oxide (TiO₂).

The unique geometry of the C1 implant encourages primary stability with mild bone compression at the upper 2/3 of the implant. The final drill, used during preparation of the osteotomy, is designed in such a way to allow less compression by the threads at the apical third of the implant, which will enable rapid bone growth in that area. These two characteristics have been put in place to minimize the period of time between initial mechanical stability and long-term biological stability.

Platform switching is a restorative concept that has been shown to minimize crestal bone loss. It has been theorized that moving the junction of the implant/abutment connection away from the outer edge of the implant platform reduces the bacterial component that could lead to loss of vertical height. For those clinicians who prefer to utilize platform switching in the restorative phase, the C1 abutments have been designed to allow this.

As with other MIS products, the surface treatment consists of both large particle blasting and acid etching. This not only creates micro- and nano-surface morphology, but also ensures a high-quality, contaminant-free surface that has been shown to achieve superb osseointegration

Here at the ICOI

To receive more information about the C1, call (866) 733-1333, visit www.misimplants.com or stop by the booths, Nos. 303/305 and Nos. 402/404.

results, according to the company. The apex of the C1 implants is dome-shaped to help prevent damage to the

mandibular nerve as well as to avoid perforation of the sinus membrane. Packaged with each C1 implant is a sterile, single-use final drill, a cover screw and a temporary PEEK abutment. Each implant (including these additional components) is sold for \$249.

• C1 Implant System.
(Photo/Provided by MIS)



You know how important photographs are to your practice, but you don't know who to turn to for advice. PhotoMed understands your **needs** and can help you choose the right camera. We also include **a** support and loan equipment program for the life of the camera so you have someone to turn to if you have questions.

PhotoMed dental cameras feature the best digital camera equipment available. The Canon G12, Rebel T3i and T4i are great choices.



Visit the PhotoMed booth at these upcoming meetings:

ICOI, Orlando - #107
AAP, Los Angeles - #1107
AAID, Wash. DC - #531
ADA, S. Francisco - #6455
ACP, Baltimore - #101

Choosing a quality **dental** system for your practice doesn't have to be difficult. Call the experts at PhotoMed and we'll help you with all of your **camera** questions.

PhotoMed www.photomed.net • 800.998.7765

AD

From intraoral scan to final custom implant restoration

By Perry E. Jones, DDS, FAGD

■ This case demonstrates the optical scanning of Inclusive® Scanning Abutments (Glidewell Laboratories; Newport Beach, Calif.) utilizing the iTero™ digital scanning system (Align Technology; San Jose, Calif.) with software version 4.0. Digital data was used with laboratory CAD/CAM planning to fabricate custom all-ceramic implant abutments and a four-unit fixed prosthesis. The abutments and fixed prosthesis were fabricated using advanced computer-aided milling technology.

Dental history

The patient was a 52-year-old healthy Hispanic male who sustained a traumatic avulsion and lost his maxillary incisors in an automobile accident. Following healing, a four-tooth transitional removable partial denture was constructed. He was seen by the oral and maxillofacial surgery service of Virginia Commonwealth University for dental implant therapy.

Treatment plan

The patient was informed of the alternatives, benefits and potential complications of various treatment options before deciding to pursue implant restoration of his missing teeth.

The treatment plan included placement of two Replace® Select Straight RP 4.3 x 13 mm implants (Nobel Biocare; Yorba Linda, Calif.) with 5 mm healing abutments, followed by a six-month healing period and restoration with all-ceramic custom abutments and a four-unit, all-ceramic fixed prosthesis to restore the anterior incisors to form and function.

Surgical procedure

Using local anesthesia, two Replace Select Straight RP implant fixtures were placed in the area of teeth #7 and #10, using standard Nobel implant placement protocol. Placement angulation and depth were verified and deemed satisfactory. Standard RP 5 mm healing abutments were placed, and the fully reflected tissue flap was closed with interrupted sutures.

Restorative procedure

Following six months of healing post-implant placement, intraoral photos were taken to record and confirm the healthy remaining dentition. Osseous integration was confirmed with a panoramic X-ray, followed by resonance frequency analysis (RFA) using an Osstell® ISQ implant stability meter with SmartPeg™ attachment (Osstell USA; Linthicum, Md.),



Fig. 1: Inclusive Scanning Abutments attached to implants. (Photos/Provided by Perry E. Jones, DDS, FAGD)



Fig. 3: Inclusive All-Zirconia Custom Abutments #7 and #10.

which displayed an implant stability quotient (ISQ) of 78 on a minimum-to-maximum scale of 1-100.

Counter rotation with a torque wrench confirmed no rotation to 35 Ncm. The implant fixtures were considered acceptable for restoration.

The 5 mm healing abutments were removed, Inclusive Scanning Abutments were placed on the implants, and the accompanying titanium screws were tightened (Fig. 1).

Using the iTero scanner with updated software (version 4.0), a full maxillary arch scan and centric bite in maximum intercuspation were completed.

A three-dimensional digital record of the patient's anatomy was created from these scans and electronically submitted to Glidewell Laboratories to be used in the CAD/CAM restoration process.

At Glidewell Laboratories, the virtual scan was registered to the scanning abutments, providing the dental technicians with the implant system, size, axis, position relative to the adjacent anatomy and locking feature orientation. A virtual zirconia abutment was designed using 3Shape's Dental-Designer™ software (3Shape Inc.; New Providence, N.J.) and the Glidewell Digital Abutment Library (Fig. 2).

From this, the corresponding physical Inclusive All-Zirconia Custom Abutments (Glidewell Laboratories) were milled.

Similarly, a BruxZir® Solid Zirconia four-unit fixed bridge (Glidewell Laboratories) was designed and milled

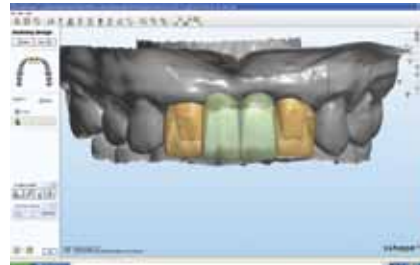

Fig. 2: Abutment planning (labial view) with 3Shape's DentalDesigner software and Prismatic CZ™ add-on module (Glidewell Laboratories).



Fig. 4: Four-unit BruxZir Solid Zirconia fixed bridge cemented in place.

using state-of-the-art CAD/CAM technology. The custom zirconia abutments were trial-fitted in the patient's mouth with slight tissue blanching noted (Fig. 3).

In the same visit, the final four-unit all-ceramic milled BruxZir Solid Zirconia bridge was tried-in and examined for proper occlusion. There was "tight" anterior coupling for this case as evidenced by the history of provisional denture fracture. The occlusion was checked and presented as so precise that no adjustment was required.

The anterior view of the final prosthesis demonstrates optimal mesial-distal width proportion, incisal edge proportion, pontic-tissue contact and excellent shade/esthetics (Fig. 4). Further, the occlusal view demonstrates an optimal incisal edge arch form. The soft-tissue lip position and speech phonetics appeared to be optimal.

Following the trial seating, the fixed bridge was removed, the zirconia abutment retention screws torqued to 35 Ncm, the abutment screws covered with cotton/Cavit™ Temporary Filling Material (3M™ ESPE™; St. Paul, Minn.), and the prosthesis cemented with GC Fuji PLUS™ (GC America; Alsip, Ill.).

* Note: Cadent (Carlstadt, N.J.) was acquired by Align Technology (San Jose, Calif.) in May 2011.

References

- Baldissara P, Llukacej A, Ciocca L, Valandro FL, Scotti R. Translucency of zirconia copings made with different CAD/

Here at the ICOI

For more information about the Inclusive Scanning Abutments, stop by Glidewell Laboratories, booth No. 214.

- CAM systems. *J Prosthet Dent.* 2010 Jul;104(1):6-12.
- Birnbaum NS, Aaronson HB. Dental impressions using 3D digital scanners: virtual becomes reality. *Compend Contin Educ Dent.* 2008 Oct;29(8): 494, 496, 498-505.
- Chang YB, Xia JJ, Gateno J, Xiong X, Zhou X, Wong ST. An automatic and robust algorithm of reestablishment of digital dental occlusion. *IEEE Trans Med Imaging.* 2010 Sep;29(9):1652-1663.
- Christensen GJ. Will digital impressions eliminate the current problem with conventional impressions? *J Am Dent Assoc.* 2008 Jun;139(6):761-763.
- Drago C, Saldarriaga RL, Domagala D, Almasri R. Volumetric determination of the amount of misfit in CAD/CAM and cast implant frameworks: a multicenter laboratory study. *Int J Oral Maxillofac Implants.* 2010 Sep-Oct;25(5):920-929.
- Ender A, Mehl A. Full arch scans: conventional versus digital impressions — an in-vitro study. *Int J Comput Dent.* 2011;14(1):11-21.
- Fasbinder DJ. Digital dentistry: innovation for restorative treatment. *Compend Contin Educ Dent.* 2010;31(4):2-11.
- Garg AK. Cadent iTero's digital system for dental impressions: the end of trays and putty? *Dent Implantol Update.* 2008 Jan;19(1): 1-4.
- Henderson, S. Align Technology Completes Acquisition of Intra-Oral Scanning Leader Cadent. 2011 May 2 [cited 2011 Oct 17]. <http://investor.aligntech.com/releasedetail.cfm?releaseid=573469>.
- Jones PE. Cadent iTero digital impression case study: full-arch fixed provisional bridge. *DCDentalcompare.* 2009 Jul 18 [cited 2011 Jul 28]. www.dentalcompare.com/Featured-Articles/2082-Cadent-iTero-Digital-Impression-Case-Study-Full-Arch-Fixed-Provisional-Bridge/.
- Jones PE. Cadent iTero optical scanning digital impressions for restorative and invisalign. *Dental Product Shopper.* 2011 Jun 28 [cited 2011 Jul 29]. <http://dental-productshopper.reachlocal.net/articles/cadent-itero-optical-scanning-digital-impressions-restorative-and-invisalign>.
- Kurbad A. Impression-free production techniques. *Int J Comput Dent.* 2011;14(1):59-66.
- Priest G. Virtual-designed and computer-milled implant abutments. *J Oral Maxillofac Surg.* 2005 Sep;63(9 Suppl 2):22-32.
- Smith R. Creating well-fitting restorations with a digital impression system. *Compend Contin Educ Dent.* 2010 Oct;31(8):640-644.
- Touchstone A, Nieting T, Ulmer N. Digital transition: the collaboration between dentists and laboratory technicians on CAD/CAM restorations. *J Am Dent Assoc.* 2010;141 Suppl 2:15S-219S.
- Zweig A. Improving impressions: go digital! *Dent Today.* 2009 Nov;28(11):100, 102, 104.

C1

A Conical Connection Implant

All C1 implants, superstructures and tools are color coded to simplify platform identification.



Platform Switching

Promotes vital soft tissue growth and reduces bone resorption

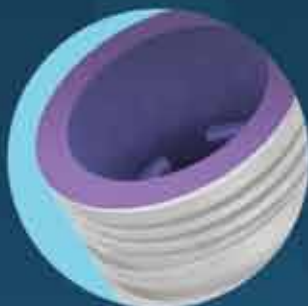

Micro Rings

Improve the bone to implant contact at the crestal zone by increasing surface area



Dual Thread Design

Increases bone to implant contact, reinforces osseointegration and enhances primary stability

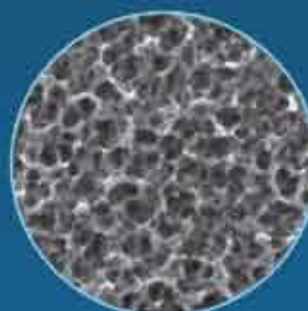

Surface Treatment

Creates an osseoconductive morphology and achieves superb osseointegration results



Visit Booth #303 at the ICOI World Congress
Priced at \$249.⁰⁰, each C1 implant is packaged with a single use final drill, cover screw, and PEEK abutment. To learn more about MIS, visit our website: www.misimplants.com or call:

866-797-1333 (toll-free)

MIS[®]
USA
Make it Simple

Scenes from the ICOI



• Richelle Braun, Justin Stefanick and Ken Hasty are ready to answer all your questions at the Piezosurgery booth, Nos. 508/510.



• Need some new camera equipment? Come talk to Tony Aguilar and Rex Koskela at the PhotoMed International booth, No. 107.



• Denise Manekas, left, and Nita Weissman-Okamoto at the Dentatus USA booth, No. 416.



• The staff members of Implantas Dentales made the trip from their practice in Costa Rica to attend the ICOI World Congress.



• Barbara Cox explains the benefits of Hands On Training at the booth, Nos. 204/206.

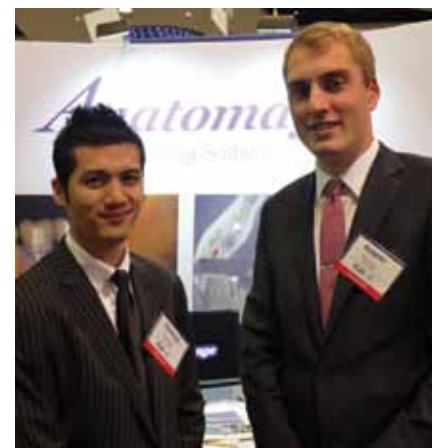

• Charles Banh, left, and Robert Chen at the Anatomage booth, No. 414.



• If you want to learn about hands-on dental implant education, go see Lissette Frias at the Implant Educators booth, No. 313.



• Find friendly faces Noel Wilford, Ben Moyal and Erin Griffin at the MIS Implant Technologies booths, Nos. 303/305 and Nos. 402/404.



• John Stephens of PreXion (booth No. 415).

**Photos by Anna
Kataoka-Wlodarczyk,
Dental Tribune**



• Diane McCullough, Bryan Loch and Kristian Malooley at the Implant Direct Sybron International booth, Nos. 607/609.



• The ADIN Implants booth (Nos. 514/416) staff is all smiles.



• Alex Miller, president of Meisinger USA, at the booth, No. 213.



• Yukari Aritake and Emiko Ota at the OSADA booth, No. 604.



• Jamy Olson and Samantha Merrick in front of the OCO Biomedical booth, No. 408.



• A family of dentists, Eduardo, Alberto, Eduardo and Enrique, all from Mexico, take in the ICOI World Congress Exhibit Hall.



• Dan Allemeier and Daniel Kohm at the Aurum Ceramic Dental Laboratories, booth No. 610.



• Paul Murphy and Peter Soto of Imaging Sciences. Come check out the i-CAT at booth Nos. 409/411.



• Damon Sementilli and Adam Driggers at the Carestream Dental/Kodak Dental Systems booth, Nos. 209/211.



Tired of Price Increases on Over-Priced Implants?

It's Time for a Reality Check. Choose Implant Direct for...
Innovative Products. Great Value. Highest Customer Satisfaction¹

Legacy™3 Implant

All-in-1 Packaging includes Implant, abutment, transfer, cover screw & healing collar
\$175 vs \$621² from Zimmer Dental

✓ **Reality Check**
Zimmer Customers:
Save \$446 with Legacy3



SwishPlant™ Implant

All-in-1 Packaging includes implant, straight abutment/transfer, cover screw & healing collar
\$200 vs \$705³ from Straumann⁴

✓ **Reality Check**
Straumann Customers:
Save \$505 with SwishPlant



ReActive™ Implant

All-in-1 Packaging includes implant, abutment, transfer & cover screw
\$200 vs \$694² from Nobel Biocare™

✓ **Reality Check**
Nobel Customers:
Save \$494 with ReActive

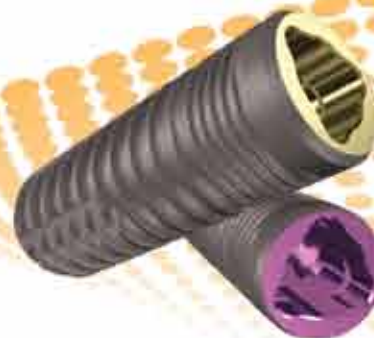

Implant Direct's New Las Vegas Training Center

Implant Direct offers an extensive list of educational opportunities at its Las Vegas Training Center with computers at each desk for Image Guided Surgical Training, models/mannequins for hands-on training and a four chair dental office for live surgical demonstrations.

Next Course: November 30-December 2

For information on courses and dates, both in Las Vegas and throughout the US, visit Implant Direct's website or use your smart phone to link directly to our Educational Section.



EARN 2 CE CREDITS FREE: View Online Lecture with 3D Graphic Videos & Answer 13 Test Questions



The Changing Reality of Implant Dentistry

Presented by Dr. Gerald Niznick
Technological advances and economic factors have shifted the implant industry toward affordable care.

Intro Offer: Make the switch & receive three FREE implants!
Buy 1 Zirconia \$120 abutment and receive 1 Free Titanium \$85 abutment⁵
(or \$85 credit for any 2nd abutment). For online orders enter ZR85 in coupon code box

Continuing education credits may not apply toward license renewal in all states. It is the responsibility of each participant to verify the requirements of his/her state licensing board(s). Live surgical demonstrations not available at all courses. All trademarks are property of their respective companies. ¹Surveyed among Current and Former Users, by Company US Q211 Millstream Research Group & Decision Research, Inc. Company. ²Price comparison based upon US list prices of comparable items as of February 2012. ³Terms and conditions apply. Limit one offer per practice. Free abutment not to exceed \$80 value. No cash value. ⁴Comparison based upon Straumann's CARES Custom Zirconia Abutment. Price varies depending upon the laboratory. LOCATOR[®] is a registered trademark of Zent Anchors Company. The GoDirect™ and GPS™ systems are neither authorized, endorsed nor sponsored by Zent Anchors Company.

Simply Smarter Prosthetic Solutions

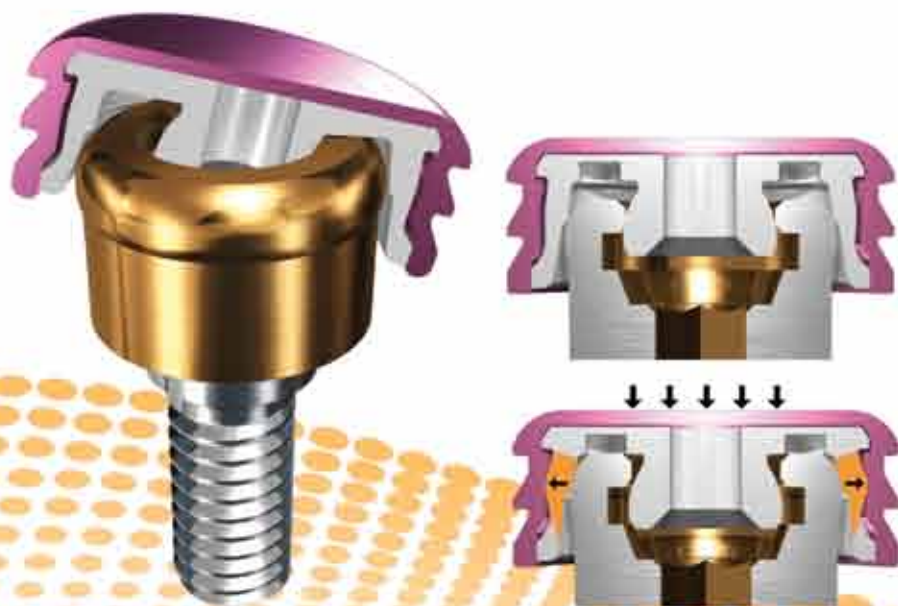

GPS® Abutment in 5 Collar Heights - \$100
NEW GPS™ Internal Attachment provides vertical and rotational stress-breaking



Zirconia Abutment on Anodized Titanium Bases - \$120

Anodized Titanium Bases for Custom Zirconia Abutments - \$60

GPS™ Overdenture Attachment System features Straight & Angled Abutments that provide a retentive platform compatible with LOCATOR® attachments. All-in-1 Packaging includes Anodized Housing with 5lbs Retentive Nylon Liner (nylon liners in 1.5, 3 & 5lbs - 4 for \$22) & Transfer. Straight Abutments accommodate up to 20° divergence while 15° & 30° Angled Abutments are suited for overdentures on angled implants.

Zirconia Abutments on Titanium Bases combine esthetics with strength & precision for restorations in the esthetic zone. The titanium base is gold anodized to maintain the natural tooth color of the zirconia while providing structural support. These stock abutments with contoured margins are provided in 0°, 8° & 15° with 1 & 2mm collar heights to minimize the need for preparation, thereby providing the benefits of custom abutments at less than half the price.

Joining our full line of industry-compatible prosthetics



Legacy™
Internal Hex
Compatible with Zimmer, BioHorizons® MIS*



ScrewPlant®
Internal Hex
with External Bevel - ID Proprietary



RePlant®
Internal Tri-Lobe
Compatible with NobelReplace™



Swish™
Internal Octagon
Compatible with Straumann Tissue Level

	Laboratory Abutment	Straight Snap-On	Straight Contoured	15° Angled Contoured	Gold/Plastic	Zirconia/Ti Abutment	Angled Zirconia/Ti Abutment	Plastic Temporary Abutment	Ball Attachment	GPS™ Attachment	Angled GPS™ Attachment	Multiple-Unit w/Cap & Transfer	
												Straight	Angled
Our price	\$75	\$85	\$85	\$85	\$100	\$120	\$120	\$35	\$107	\$100	\$120	\$85	\$100
Zimmer Dental™	\$160	\$215	\$170	\$180	\$210	\$239	\$254	\$67	\$178	\$166	N/A	\$202	\$294
Straumann®	N/A	\$190	\$195	\$195	\$255	\$339 ^h	\$339 ^h	\$65	\$275	\$195	N/A	\$180	N/A
Nobel Biocare™	\$145	\$186	\$170	\$225	\$216	\$285	\$285	\$72	\$217	\$149	N/A	\$229	\$274

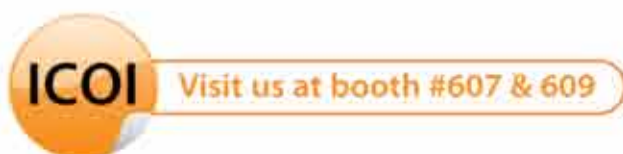

www.implantdirect.com | 888-649-6425