

today

04
05
06

EAO 26th Annual Scientific Meeting Madrid • 5-7 October 2017

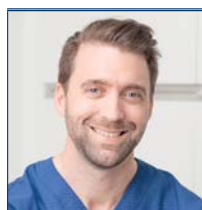

Interview

Dr Pär Johansson about the advantages and challenges of PEEK implants and what the new material could mean for the future of implantology.

» page 8pp



Business

Shifting consumer preferences, positive uptake of CAD/CAM technology and other developments in the European dental implant market.

» page 20



Products in focus

The EAO-SEPES meeting will be an excellent opportunity to see the most up-to-date innovations and technologies in dental implantology.

» page 23

The next full-arch revolution

With Trefoil, Nobel Biocare presents a definitive fixed solution to treat more patients better

■ Nobel Biocare has continually led innovation in full-arch solutions for over 50 years. Now, the company has achieved another breakthrough in the efficient treatment of the edentulous mandible. The launch of the new Trefoil system has made the passive fit of a pre-manufactured bar possible for the very first time, using a revolutionary, self-adjusting fixation mechanism and just three implants. An innovation that drives efficiency at

every step, from manufacture to definitive restoration, the Trefoil system makes a fixed full-arch implant solution a real possibility for more patients.

More patients benefit from a fixed solution

The benefits of fixed solutions far outweigh the costs of fixed-removable solutions for many patients when considering implant-supported solu-

tions.¹ While a removable implant rehabilitation may offer a lower price and faster treatment than typical fixed alternatives, many patients desire the comfort and ease of a fixed prosthesis,² which has been proven to significantly improve quality of life.³ Fixed solutions also offer enhanced function with a higher bite force and better retention and stability, and avoid some of the disadvantages of removable solutions, such as more

mucosal problems and the wear of components.⁴

Developed with the needs of the many in mind, the efficiency of the Trefoil system empowers clinicians to provide many patients who are held back by time or finances with the premium-quality fixed solution they deserve.



Fig. 1

today → 2

*Fig. 1: The Trefoil system offers a precision-milled bar with self-adjusting joints for a passive fit.

*Fig. 2: The mechanism allows screws to self-adjust in compensation for inherent deviations from each implant's ideal height, angulation and position.

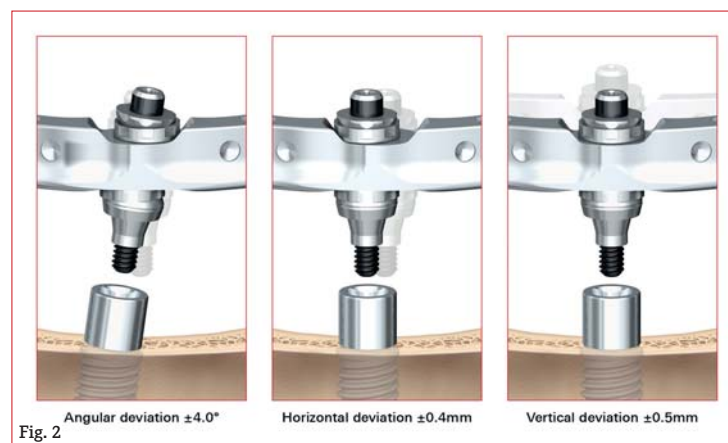

Fig. 2

AD

MORE INVENTIVE LESS INVASIVE

DENTAL AND MEDICAL TECHNOLOGIES

17 av. Gustave Eiffel | BP 30216
33708 MERIGNAC cedex | FRANCE
Tel + 33 (0) 556 340 607 | Fax + 33 (0) 556 349 292
E-mail: info@acteongroup.com | www.acteongroup.com

Implant community gathers in Madrid for EAO 2017

■ After the FDI World Dental Congress in August, the Feria de Madrid fairgrounds will open its doors again today for dental professionals from around the world. From 5 to 7 October, thousands will be able to learn everything there is to know about dental implantology and oral rehabilitation at the 26th annual congress of the European Association for Osseointegration (EAO).

Organised in partnership with the Spanish society of prosthodontic and aesthetic dentistry (Sociedad Española de Prótesis Estomatológica y Estética), an association with a membership of 4,500, the conference is poised to attract thousands of specialists from all over the globe to Madrid. Spanning three days, the meeting will offer a number of high-class clinical lectures, hands-on sessions and industry symposia under the theme of "Twenty-five years of implant dentistry. What have we learned?". According to the organisers, it will furthermore provide interactive opportunities for audience involvement, such as surgical video sessions.

Overall, more than 50 clinical experts from all over the world will be speaking at this year's event. Among them are prominent figures in dentistry, such as Prof. Mariano Sanz from Spain, Dr Christian Coachman from Brazil and Dr Christoph Hämmerle from Switzerland. In the guest country session, clinicians from Latin America will be presenting their research to a professional audience for the first time.



* Implant specialists from all over the globe will attend the congress at Feria de Madrid. (Photograph: IFEMA, Spain)

While most of the presentations will be in English, the organisers have announced that there will be simultaneous interpreting into Spanish for some of the sessions.

Furthermore, a record number of 139 manufacturers and dealers (as of 21 September), including international heavyweights like Nobel Biocare, Straumann and Dentsply

Sirona, have registered for the accompanying trade exhibition, which will showcase the latest innovations. Attendees will also be able to learn about the new products and clinical solutions in detail at industry symposia that will run concurrently with the main programme.

Founded in 1991 by leading dentists interested in osseointegration,

the EAO is now a worldwide authority in the fields of reconstructive surgery and prosthetic rehabilitation. In addition to its large annual event, the association holds master clinical courses throughout the year. It furthermore offers members and non-members the opportunity to obtain a postgraduate diploma in implant dentistry.

Information about the 2017 congress and programme is available at the congress website and through the EAO SEPES 2017 mobile app, which can be downloaded from the iTunes Store and Google Play. The latest news from the show floor, interviews with opinion leaders, and impressions will be available at www.dental-tribune.com. ◀◀

today ← 1 Definitive teeth in a day*

Dental implant patients are increasingly requesting immediate restorations and reduced treatment

The Trefoil system, combining a pre-manufactured titanium bar, three implants, a simplified restorative workflow, acrylic prosthesis and minimised restorative componentry, ena-

the day of surgery* using a prefabricated bar and wrap-around acrylic technique for the prosthesis saves substantial time for the restorative clinician, the laboratory and ultimately the patient.

First pre-manufactured bar with a passive fit

Before the Trefoil system, prefabricated bars could be cost-efficient, but none could enable the passive fit that is so crucial to long-term treatment success. In challenging this limitation, Nobel Biocare engineers developed the first pre-manufactured bar with a passive fit, enabled by a unique fixation mechanism with self-adjusting joints. This mechanism provides passive fit by compensating for horizontal, vertical and angular deviations from the ideal placement of the three implants. Accurate

drilling with standardised drill guides enables precise parallel implant positioning and placement for passive fit.

Proven implant design with conical connection

A special component of the Trefoil system is the Trefoil Implant. It combines the proven parallel-wall

implant design, a machined soft-tissue collar—which allows easy access to the implant while leaving the soft tissue undisturbed after the surgery—and a conical connection. The TiUnite surface is proven to maintain implant stability during the critical healing phase through rapid bone formation⁷⁻⁹ and it promotes long-term success.

Treatment success

Results from an ongoing five-year multicentre study across four continents are already being reported for implant and prosthetic survival rates.⁶ This important study has been expanded to include 110 patients at the request of clinicians, to meet the needs of their patients.

Treating a whole new patient population with a fixed solution

The decline in edentulism has been predicted to slow and to be partially offset by a growing and ageing population.¹⁰ High-quality and cost-efficient solutions are crucial for serving the needs of edentulous patients and patients with a failing dentition.

In essence, the Trefoil system embodies the Nobel Biocare mission to treat more patients better. With this improved efficiency comes the opportunity to continue with the vision of Per-Ingvar Brånemark and bring the benefits of osseointegration to a whole new patient population. ◀◀

Editorial note: A list of references is available from the publisher.

More informations are available online at nobelbiocare.com/trefoil.

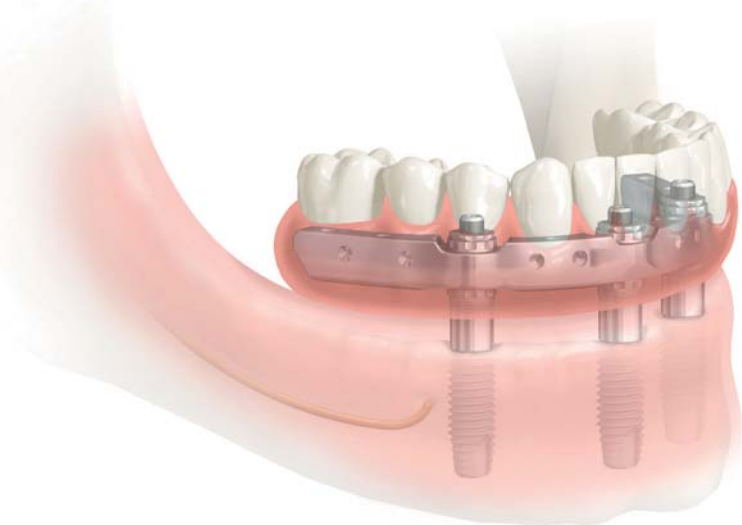

Fig. 3

* Fig. 3: The Trefoil system, specially designed to work on three implants and enabling definitive teeth on the day of surgery,* reduces time and cost in comparison with other fixed implant solutions.

* Depending on clinical preference and close cooperation with the laboratory

time. Meeting this need and avoiding an edentulous state during treatment encouraged the introduction of an immediate loading protocol. Dental professionals seek solutions with fewer surgical steps, but with high success rates, high patient satisfaction and function on the day of surgery.^{4,5}

bles shorter time to teeth and reduced chair time compared with conventional treatments that use provisional restorations. With no need for CAD/CAM or temporary prostheses, the ability to place definitive teeth on

* Depending on clinical preference and close cooperation with the laboratory

today about the publisher		dti Dental Tribune International	
Editorial/Administrative Office Dental Tribune International GmbH Holbeinstraße 29 04229 Leipzig, Germany Phone: +49 341 48474-302 Fax: +49 341 48474-173 Internet: www.dental-tribune.com		Business Development Claudia Salwiczek-Majonek	
Publisher Torsten Oemus		Product Manager Antje Kahnt	
Director of Finance and Controlling Dan Wunderlich		Production Executive Gernot Meyer	
Managing Editor Daniel Zimmermann		Production Matthias Abicht	
Editorial Assistance Monique Mehler		<i>today</i> will appear at the 26 th EAO Annual Scientific Meeting in Madrid, 5–7 October, 2017. The magazine and all articles and illustrations therein are protected by copyright. Any utilisation without prior consent from the editor or publisher is inadmissible and liable to prosecution. No responsibility shall be assumed for information published about associations, companies and commercial markets. General terms and conditions apply, legal venue is Leipzig, Germany.	

VISIT US AT THE EAO BOOTH G11



LUNCH SYMPOSIUM

Saturday, October 7, 2017
13.00 – 14.00

Symposium Room 113
Capacity: 150 max.

CEREC[®] Implant workflow made iSy[®]

CARLOS REPULLO, DDS, Implantology, Prosthodontics

CEREC[®] IS A REGISTERED TRADEMARK OF DENTSPLY SIRONA.



CAMLOG Biotechnologies AG
is a Gold Sponsor

www.camlog.com

a perfect fit[™]

camlog

MIS Global Conference

Bahamas to host fourth edition in February 2018

■ The next MIS Global Conference will take place from 8 to 11 February next year in the beautiful Atlantis Resort in the Bahamas. Based on the success of last year's event in Barcelona in Spain, with its fascinating scientific programme, high-level lec-

tures and amazing entertainment, the next edition promises to deliver an intense and unforgettable experience in every respect.

The scientific committee, headed by Prof. Lior Shapira, Chairman of the Department of Periodontics at the



Hebrew University–Hadassah Faculty of Dental Medicine in Jerusalem in Israel, has undertaken all efforts to make the next conference even better than the one before. In addition to contemporary treatment possibilities, insight will be provided into the present and future of dental implants as part of clinical dentistry.

“The podium will be occupied by high-quality clinicians, researchers, and educators, who will share with you their extraordinary experience and clinical excellence,” Shapira said.

With the launch of the V3 Implant System currently underway in the US market, MIS Implants Technologies is devoted to equipping the dental community with the latest innovations and helping clinicians improve patient care. The two-day main programme will feature world-prominent speakers presenting their expertise, which could be implemented in everyday dental practice and optimize dentists' skills for the benefit of their patients. Some of the key topics of the conference are evolution and horizons in implant therapy, biological principles and predictable aesthetics, the long-term forecast for implant therapy and going digital (where, when and how). A number of workshops will provide an opportunity for meaningful learning in an intimate environment, with accomplished experts in their specific fields of interest.

As part of its commitment to promoting young clinicians, MIS is continuing the tradition of holding a clinical case competition during its conference. With the focus on modern technologies and techniques in clinical practice this year, 15 top clinical cases will be presented as posters at the conference venue, and the best three will also be awarded.

In the spirit of “ideas worth spreading” and its commitment to innovation, MIS has further proudly announced a new partnership with TEDx. An independently organised TED event, TEDxMIS will be held on 10 February and feature some of the world's leading thinkers and achievers in the field of implant dentistry. The goal is to give conference guests the opportunity to experience a unique series of fast-paced, eye-opening talks that will inspire them and provoke meaningful engagements with their peers.

Similar to past events, the Bahamas conference is expected to provide an extraordinary environment for knowledge sharing and the opportunity to meet with peers in the international dental community. In 2018, conference guests will also enjoy one of the most beautiful and exotic locations in the Atlantic Ocean: the Atlantis Resort on Paradise Island. When not engaged in the workshops and lectures, they will be able to explore this extraordinary marine habitat, participate in sports activities, and experience the culture and colours of the Bahamas. Full of impressive and fun events, the MIS Global Conference entertainment programme will leave guests with fond memories and looking forward to the next meeting.

More information about the conference can be found at *bahamas.mis-implants.com* or at Booth P1 in the exhibition hall at EAO 2017. ◀

AD

International Magazines

implants

international magazine of oral implantology

www.dental-tribune.com



EUR 44 per year (4 issues per year; incl. shipping and VAT for customers in Germany) and EUR 46 per year (4 issues per year; incl. shipping for customers outside Germany).

Your subscription will be renewed automatically every year until a written cancellation is sent to Dental Tribune International GmbH, Holbeinstr. 29, 04229 Leipzig, Germany, six weeks prior to the renewal date.

Shipping Address

Name

Address

Zip Code, City

Country

E-mail

Date, Signature

PayPal Credit Card

Credit Card Number Expiration Date Security Code

SUBSCRIBE NOW!

F +49 341 48474 173
subscriptions@dental-tribune.com





Reliable
Experience
Original
Forever



GLEU-536-082917
MKT 8443_1.0 REV ID 9586

GLIDEWELL DIRECT EUROPE
CLINICAL AND LABORATORY PRODUCTS

eu.glidewelldirect.com
+49 (0) 69 – 5060 053 12

Nano-coating effective in reducing peri-implantitis risk

Combination of silver, titanium dioxide and hydroxyapatite shows promising results in UK study

■ Investigating the effect of a new approach using a combination of silver, titanium dioxide and hydroxyapatite (HA) nano-coatings on the surface of titanium alloy implants, researchers from Plymouth in the UK have found that the method was successful in inhibiting bacterial growth and reducing the formation of bacterial biofilm. In addition, the coating created a surface with anti-biofilm properties, thus supporting successful integration of the implants into surrounding bone and accelerating bone healing.

One of the main reasons for dental implant failure is peri-implantitis, an inflammatory process affecting the soft and hard tissue surrounding dental implants caused by pathogenic microbes that develop into biofilms. Current approaches to managing the development of biofilms include application of antimicrobial coatings loaded with antibiotics or chlorhexidine. However, these are usually only short-term measures. In addition, chlorhexidine has been reported to be potentially toxic to human cells.

Investigating a new approach to the prevention of biofilm, research-

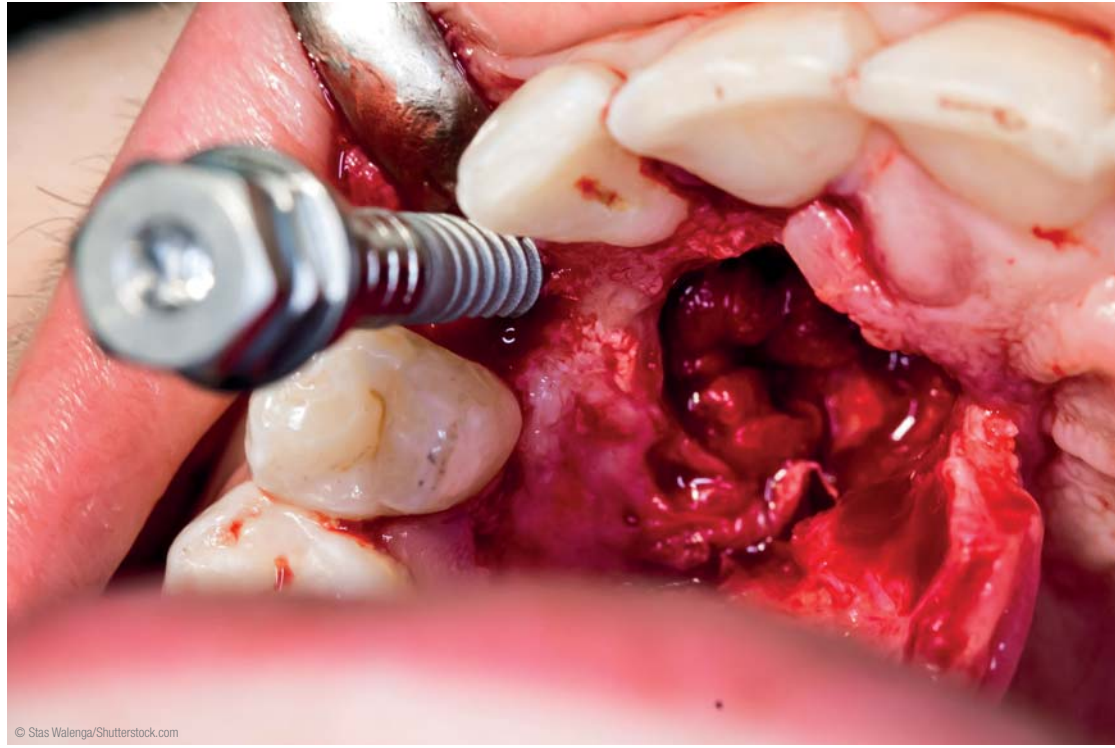

© Stas Walenga/Shutterstock.com

ers from the School of Biological Sciences, Peninsula Schools of Medicine and Dentistry, and School of Engineering at the University of Plymouth tested the effectiveness of a

dual-layered silver-HA nano-coating on titanium alloy medical implants. The antibacterial performance of the coating was quantitatively assessed by measuring the growth of *Strepto-*

coccus sanguinis, the proportion of live and dead cells, and lactate production by the microbes over 24 hours. The results showed that the combination successfully inhib-

ited bacterial growth and reduced the formation of bacterial biofilm on the surface of the implants by 97.5 per cent. Uncoated controls and titanium dioxide nano-coatings showed no antibacterial effect.

According to the researchers, no dissolution was detected for the HA nano-coatings. Thus, application of a dual-layered silver-HA nano-coating on titanium alloy implants further created a surface with anti-biofilm properties without compromising the HA biocompatibility required for successful osseointegration and accelerated bone healing.

"In this cross-faculty study we have identified the means to protect dental implants against the most common cause of their failure. The potential of our work for increased patient comfort and satisfaction, and reduced costs, is great and we look forward to translating our findings into clinical practice," commented Prof. Christopher Tredwin, Head of the Peninsula School of Dentistry.

In the next step, the effectiveness of the approach needs to be tested *in vivo*, according to the researchers. ◀

Global dental implant market to rise in value

■ A recent report on the global dental implant market has forecast a compound annual growth rate of 7.9 per cent for the industry until 2024. The report was compiled by Transparency Market Research and predicts that this market will be worth US\$8.18 billion by the end of the analysis period.

This expected continued growth can be attributed to a number of factors. With ageing populations worldwide, more people than ever before are being treated for dental problems. Furthermore, advancements in CAD/CAM technology and increasing recognition of the importance of maintaining good oral hygiene are contributors, the report stated.

Titanium implants and zirconia implants were identified as two key segments of this market, with the former expected to be both the leading revenue generator and the fastest-growing segment. Titanium alloys used in dentistry are lightweight, resistant to corrosion and wear, and

able to withstand high temperatures. Zirconia implants offer a metal-free alternative and provide excellent osseointegration and aesthetic properties.

According to the report, Europe was leading the global dental implant market by overall demand at the start of the forecast period, closely followed by North America. The Asia-Pacific region is the fastest growing market, however, as demand for medical facilities continues to increase there.

The report, titled *Dental Implants Market (Products—Endosteal Implants, Subperiosteal Implants, Transosteal Implants, and Intramucosal Implants; Materials—Titanium Implants and Zirconium Implants; End Users—Hospitals, Dental Clinics, and Academic and Research Institutes)—Global Industry Analysis, Size, Share, Growth, Trends, and Forecast 2016–2024*, can be purchased from the Transparency Market Research website. ◀

Spanish study finds strong link between OSA and implant complications

■ There has been increasing awareness of the reciprocal relationship between obstructive sleep apnoea (OSA) and dental problems, for example sleep bruxism and a higher

sleep disorder and implant complications.

Aiming to analyse the frequency of prosthetic complications in implant-borne prostheses, a group of re-

searchers. Moreover, the highest apnoea-hypopnoea index score, and thus the severity of OSA, was identified in patients with a fracture complication related to an implant, a

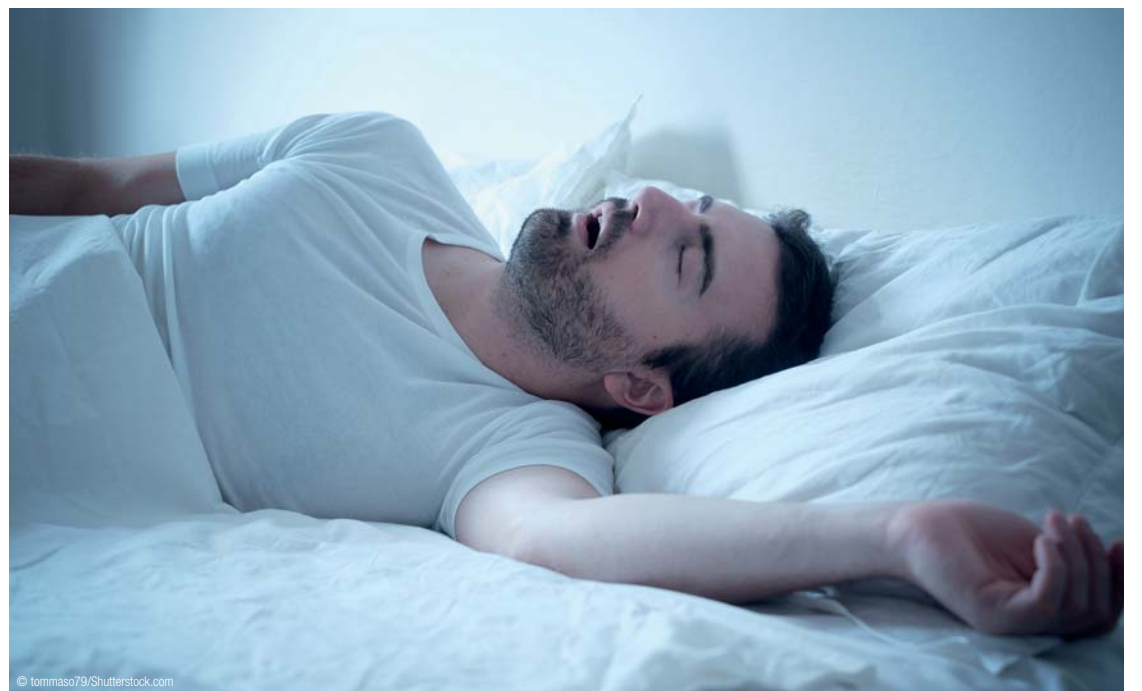

© tommaso79/Shutterstock.com

clench index. However, few studies have investigated the role of OSA in the occurrence of technical failure in fixed prostheses, especially those that are implant-borne. Spanish research conducted by dentists in collaboration with the OSI Araba University Hospital in Vitoria has now found that over 80 per cent of the patients with OSA experienced implant problems—suggesting a potentially strong correlation between the

searchers from Vitoria investigated implant failure in 67 patients. They identified 30 complications affecting 22 prostheses among 16 patients. Of these, 13 also had OSA (81 per cent).

Complications included porcelain fracture (14 events), screw/implant fracture (eight events), screw loosening (three events) and de-cementation (five events). According to the researchers, most of the complications occurred in the posterior seg-

screw or a porcelain crown, the study showed. The average time for problem occurrence was 73 months after insertion of the implant.

Based on the results, which suggest a strong link between OSA and implant complications, the researchers noted that future studies should explore the correlation further in order to better understand the risk factors and frequencies of these occurrences. ◀

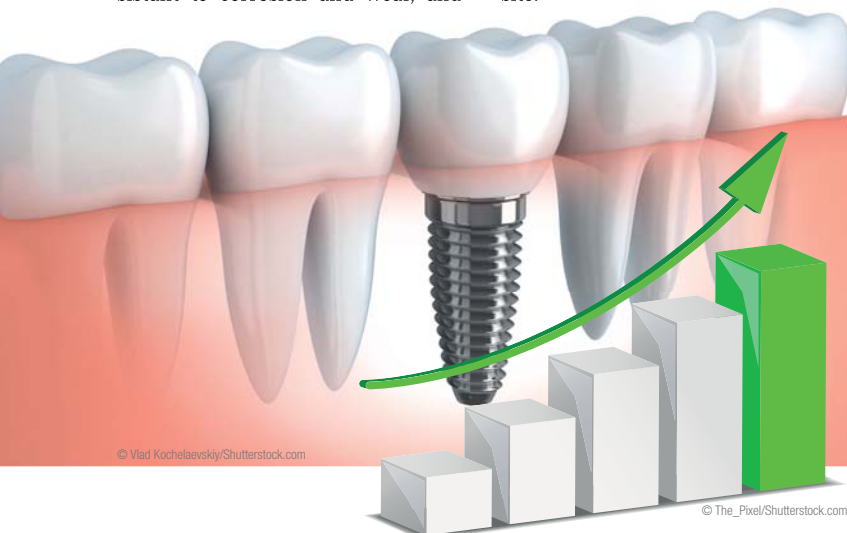

© Vlad Kochelavsky/Shutterstock.com

© The_Pixel/Shutterstock.com



INSPIRING SPEAKERS. BREATHTAKING VIEWS
MAKE IT SIMPLE

MIS is proud to introduce the Global Conference Speakers Team: • Yuval Jacoby • Ignacio Sanz Sánchez • Vincent Fehmer • Emilio Arguello • Eric Van Dooren • Galip Gürel • Mauro Fradeani • Christian Stappert • Myron Nevins • Joseph Kan • Edward P. Allen • German O. Gallucci • Lesley David • Stefan Koubi • Leila Jahangiri • Carlo Marinello • Ariel J. Raigrodski • Mirela Feraru • Tali Chackartchi • Tommie Van De Velde • Pablo Galindo-Moreno • Stavros Pelekanos • Juan Arias Romero • Victor Clavijo • Anas Aloum • Gustavo Giordani. To learn more about the conference visit: www.mis-implants.com/bahamas

MIS[®]



“Research on PEEK implants is both challenging and motivating”

An interview with EAO presenter Dr Pär Johansson, Sweden

■ In 2010, Dr Pär Johansson received his dentistry degree at Malmö University in Sweden, where he submitted a master thesis on implant surfaces. A few years later, he joined a research team at the same department as they were launching an interesting project on a new implantable material, PEEK (polyetheretherketone). In an interview with *today international* Johansson spoke about the advantages and challenges of PEEK implants and what the new material could mean for the future of implantology.

today international: What, in your opinion, has been the greatest development in dental implantology throughout the decades?

Dr Pär Johansson: Since the discovery of osseointegration, the development of dental implantology has been extraordinary and extremely fast. The advancement began by experimenting with different implant materials and inventive shapes and forms. Thereafter, the implant surface was modified using several subtractive and additive methods to shorten the healing time and increase the success rate. Today, researchers are attempting to improve osseointegration by loading the implant surface with pharmaceuticals or proteins. As a researcher, I would say that the most important developments in dental implantology have been the surface improvements and, to some extent, our understanding of bone and implant interaction. As a clinician, the greatest developments have been improved treatment protocols and the implementation of digital appliances.

At the 2017 European Association for Osseointegration (EAO) congress, you will be giving a lecture about PEEK implants. What was your motivation behind specialising in this implant material?

The project became my PhD project, which I am defending later this year. PEEK is a highly advanced polymer with properties that could improve the treatment outcomes of several procedures. The challenge is that PEEK is not optimal as a loadbearing



*Dr Pär Johansson works in the PCR lab in Malmö University, Sweden. He's doing PCR (polymerase chain reaction) to evaluate gene-expression on PEEK implants implanted in rabbit bone. In detail he is pipetting specific primers that he wish to analyse.

procedures and ongoing research has introduced more applications. In dentistry, the introduction of PEEK has been slow, but the material may well be functional in healing abutments, temporary cylinders and dental frameworks. Introduction of new biomaterials is a slow process which require a comprehensive evaluation by the U.S. Food and Drug Administration before it can be implemented for clinical trials. PEEK-OPTIMA (Invibio) is currently the only commercial PEEK polymer approved by the FDA as a medical device.

What are the main advantages of PEEK in comparison with conventional implant materials like titanium? What are its limitations?

The main advantage in spine and trauma surgery is its superior biome-

chanical properties compared with metals. PEEK has an elastic modulus similar to that of human bone, while that of titanium is almost eightfold higher. Differences in elastic modulus between the implant and the surrounding tissue may promote stress shielding and inhibit bone growth or lead to bone resorption. Furthermore, titanium and metal alloys have, in some documented cases, caused signs of hypersensitivity and allergy. These days, there is also an increasing demand for non-metallic restorations and biomaterials. PEEK is bio-inert, has a non-reactive surface and, according to current literature, has

never shown any signs of provoking hypersensitivity. The colour of PEEK is more natural, and this enables the manufacturing of aesthetic implants for thin biotypes and diverse dental components. Finally, PEEK is transparent to X-rays, which is a feature highly useful after spine surgery, al-

lowing the postoperative radiograph to be viewed and analysed without any disturbing artefacts.

The results of a study in rabbit bone you conducted in 2016 proved that the addition of a nanosized hydroxyapatite-coating to PEEK surfaces improved the bone-implant contact and demonstrated strong osteoconductive properties at the perforation. How important are these findings to advancing research on PEEK implants?

This aforementioned study is the third by our research group on PEEK. There were two main areas of investigation regarding the material used in this study, the use of PEEK as a biomaterial and the innovative coating technique by which a nanosized hydroxyapatite coating is applied to the implant surface. Further, this study

today → 10

PEEK is not optimal as a loadbearing implant.

implant because of the bio-inert surface which does not osseointegrate without modification. Therefore, research on PEEK implants is both challenging and motivating, particularly since the arena of applications, especially in dentistry, is so unexplored.

It has been argued that implantable PEEK polymers are a next-generation biomaterial. Is that fact or fantasy?

I would say that PEEK has come a long way to becoming the next-generation biomaterial in the orthopaedic field. Today, PEEK is the standard implant material in several spinal

implant because of the bio-inert surface which does not osseointegrate without modification. Therefore, research on PEEK implants is both challenging and motivating, particularly since the arena of applications, especially in dentistry, is so unexplored.



*Dr Johansson is examining histological sections of the implant in rabbit bone before looking at this in the microscope. This is a histological image from a PEEK implant with a hydroxyapatite coating. This one is implanted into rabbit bone and retrieved after three weeks of healing. At the bottom of the implant you can see the osteoconductive properties of hydroxyapatite on PEEK as the bone bends and grow along the implant surface.



Targeting Perfection

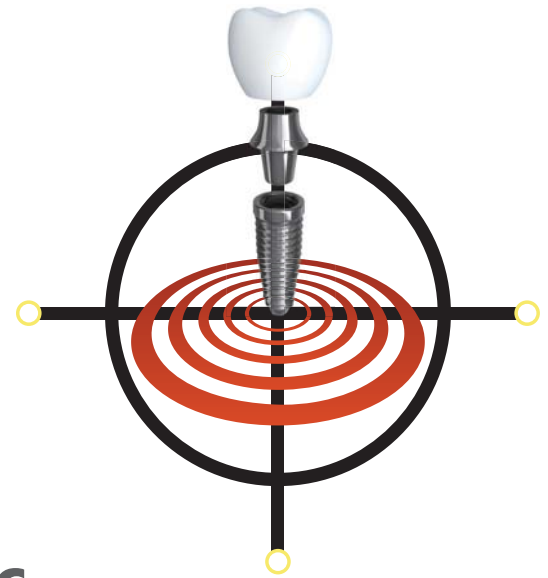

Join the EAO workshop on dynamic navigation for freehanded dental implantation

When: Friday, October 6, 2017 at 9:00 or 13:30

Lecturers: Dr. Hadi Antoun (FR), Dr. Josep Arnabat (SP), Dr. Rui Figueredo (SP)

See for yourself how freehanded guided surgery aids more accurate implant placement. Navident tracks the drill and the patient's jaw, providing real-time tactile guidance and visual feedback.



- Precision guidance for increased accuracy within 0.5mm of treatment plan*
- Easy to use, reducing time and expense with a simplified workflow
- Provides even greater value from your CBCT data
- Enables minimally invasive flapless drilling without a physical guide

Compatible with any implant type, drill system and all CBCTs currently on the market

"In contrast to surgical guides, Navident provides me with much more information during surgery, which allows me to place implants in a quicker, safer and more enjoyable way."

Dr. Luigi Vito Stefanelli, DDS
Rome, Italy

*Average error of 0.4mm in internal bench tests with a range of operating conditions.



Try Navident's precision guidance for yourself.

Visit us at Booth n° S31 at EAO-SEPES joint meeting 2017



Intro to Dynamic Navigation Using Navident with Hands-On Workshop

To subscribe, please visit the EAO registration desk.

Limited places available.

This hands-on workshop will be held during the EAO-SEPES joint meeting 2017 in order to introduce the clinician to the surgical aspects of dynamic navigation using the Navident system. It starts with an introduction to the technology and workflow, followed by case presentations from an experienced implant surgeon. Theory is put into practice through a hands-on workshop with models.